

Data Sheet

Description

These Precision Optical Performance AllnGaP LEDs provide superior light output for excellent readability in sunlight and are extremely reliable. AllnGaP LED technology provides extremely stable light output over long periods of time. Precision Optical Performance lamps utilize the aluminum indium gallium phosphide (AllnGaP) technology.

These LED lamps are untinted, nondiffused, T-1 $\frac{3}{4}$ packages incorporating second-generation optics producing well defined spatial radiation patterns at specific viewing cone angles.

These lamps are made with an advanced optical grade epoxy, offering superior high temperature and high moisture resistance performance in outdoor signal and sign applications. The high maximum LED junction temperature limit of +130 °C enables high temperature operation in bright sunlight conditions. The package epoxy contains both uv-a and uv-b inhibitors to reduce the effects of long-term exposure to direct sunlight.

These lamps are available in two package options to give the designer flexibility with device mounting.

Benefits

- Viewing angles match traffic management sign requirements
- Colors meet automotive and pedestrian signal specifications
- Superior performance in outdoor environments
- Suitable for autoinsertion onto PC boards

Features

- Well-defined spatial radiation patterns
- Viewing angles: 8°, 15°, 23°, 30°
- High luminous output
- Colors:
 - 590 nm amber
 - 605 nm orange
 - 615 nm reddish-orange
 - 626 nm red
- High operating temperature: $T_{jLED} = +130^{\circ}\text{C}$
- Superior resistance to moisture
- Package options:
 - With or without lead stand-offs

Applications

- Traffic management:
 - Traffic signals
 - Pedestrian signals
 - Work zone warning lights
 - Variable message signs
- Commercial outdoor advertising:
 - Signs
 - Marquees
- Automotive:
 - Exterior and interior lights

Device Selection Guide

Table 1 Device Selection Guide, 8° Typical Viewing Angle

Typical Viewing Angle $2\theta_{1/2}$ (Deg) ^a	Color and Dominant Wavelength (nm), Typ ^b	Lamps without Standoffs on Leads (Outline Drawing A)	Lamps with Standoffs on Leads (Outline Drawing B)	Luminous Intensity I _v (mcd) ^{c,d,e} at 20 mA	
				Min	Max
8°	Amber 590	HLMP-EL08-T0000	—	2500	—
		HLMP-EL08-VY000	HLMP-EL10-VY000	4200	12000
		HLMP-EL08-WZ000	—	5500	16000
		HLMP-EL08-X1K00	HLMP-EL10-X1K00	7200	21000
		HLMP-EL08-X1000	HLMP-EL10-X1000	7200	21000
	Orange 605	HLMP-EJ08-WZ000	—	5500	16000
		HLMP-EJ08-X1000	HLMP-EJ10-X1000	7200	21000
		HLMP-EJ08-Y2000	—	9300	27000
	Red-Orange 615	HLMP-EH08-UX000	—	3200	9300
		HLMP-EH08-WZ000	HLMP-EH10-WZ000	5500	16000
		HLMP-EH08-Y2000	HLMP-EH10-Y2000	9300	27000
	Red 626	HLMP-EG08-T0000	—	2500	—
		HLMP-EG08-VY000	—	4200	12000
		HLMP-EG08-WZ000	HLMP-EG10-WZ000	5500	16000
		HLMP-EG08-X1000	HLMP-EG10-X1000	7200	21000
		HLMP-EG08-YZ000	—	9300	16000
		HLMP-EG08-Y2000	HLMP-EG10-Y2000	9300	27000

- $\theta_{1/2}$ is the off-axis angle where the luminous intensity is half the on-axis intensity.
- The dominant wavelength, λ_d , is derived from the CIE Chromaticity Diagram and represents the color of the lamp.
- The luminous intensity is measured on the mechanical axis of the lamp package.
- The optical axis is closely aligned with the package mechanical axis.
- Tolerance for each intensity bin limit is $\pm 15\%$.

Table 2 Device Selection Guide, 15° Typical Viewing Angle

Typical Viewing Angle $2\theta_{1/2}$ (Deg) ^a	Color and Dominant Wavelength (nm), Typ ^b	Lamps without Standoffs on Leads (Outline Drawing A)	Lamps with Standoffs on Leads (Outline Drawing B)	Luminous Intensity I _v (mcd) ^{c,d,e} at 20 mA	
				Min	Max
15°	Amber 590	HLMP-EL15-PS000	—	880	2500
		HLMP-EL15-QSK00	—	1150	2500
		HLMP-EL15-QT000	—	1150	3200
		HLMP-EL15-UX000	HLMP-EL17-UX000	3200	9300
		HLMP-EL15-VY000	HLMP-EL17-VY000	4200	12000
		HLMP-EL15-VYK00	—	4200	12000
	Orange 605	HLMP-EJ15-PS000	—	880	2500
		HLMP-EJ15-SV000	HLMP-EJ17-SV000	1900	5500
	Red-Orange 615	HLMP-EH15-RU000	—	1500	4200
		HLMP-EH15-TW000	—	2500	7200
	Red 626	HLMP-EG15-PS000	—	880	2500
		HLMP-EG15-QT000	—	1150	3200
		HLMP-EG15-RU000	—	1500	4200
		HLMP-EG15-UX000	HLMP-EG17-UX000	3200	9300
		HLMP-EG15-TW000	—	2500	7200

- $\theta_{1/2}$ is the off-axis angle where the luminous intensity is half the on-axis intensity.
- The dominant wavelength, λ_{dr} , is derived from the CIE Chromaticity Diagram and represents the color of the lamp.
- The luminous intensity is measured on the mechanical axis of the lamp package.
- The optical axis is closely aligned with the package mechanical axis.
- Tolerance for each intensity bin limit is $\pm 15\%$.

Table 3 Device Selection Guide, 23° Typical Viewing Angle

Typical Viewing Angle 2θ _{1/2} (Deg) ^a	Color and Dominant Wavelength (nm), Typ ^b	Lamps without Standoffs on Leads (Outline Drawing A)	Lamps with Standoffs on Leads(Outline Drawing B)	Luminous Intensity I _v (mcd) ^{c,d,e} at 20 mA	
				Min	Max
23°	Amber 590	HLMP-EL24-PS000	HLMP-EL26-PS000	880	2500
		HLMP-EL24-QRK00	—	1150	1900
		HLMP-EL24-QS400	—	1150	2500
		HLMP-EL24-QT000	HLMP-EL26-QT000	1150	3200
		HLMP-EL24-SU400	—	1900	4200
		HLMP-EL24-TW000	—	2500	7200
	Orange 605	HLMP-EJ24-QT000	—	1150	3200
	Red-Orange 615	HLMP-EH24-PS000	HLMP-EH26-PS000	880	2500
		HLMP-EH24-QT000	—	1150	3200
		HLMP-EH24-RU000	—	1500	4200
	Red 626	HLMP-EG24-PS000	HLMP-EG26-PS000	880	2500
		HLMP-EG24-QT000	—	1150	4200
		HLMP-EG24-RU000	—	1500	4200

- θ_{1/2} is the off-axis angle where the luminous intensity is half the on-axis intensity.
- The dominant wavelength, λ_d, is derived from the CIE Chromaticity Diagram and represents the color of the lamp.
- The luminous intensity is measured on the mechanical axis of the lamp package.
- The optical axis is closely aligned with the package mechanical axis.
- Tolerance for each intensity bin limit is ±15%.

Table 4 Device Selection Guide, 30° Typical Viewing Angle

Typical Viewing Angle 2θ _{1/2} (Deg) ^a	Color and Dominant Wavelength (nm), Typ ^b	Lamps without Standoffs on Leads (Outline Drawing A)	Lamps with Standoffs on Leads (Outline Drawing B)	Luminous Intensity I _v (mcd) ^{c,d,e} at 20 mA	
				Min	Max
30°	Amber 590	HLMP-EL30-MQ000	—	520	1500
		HLMP-EL30-PQ000	—	880	1500
		HLMP-EL30-PR400	—	880	1900
		HLMP-EL30-PS000	HLMP-EL32-PS000	880	2500
		HLMP-EL30-PSK00	—	880	2500
		HLMP-EL30-QT000	—	1150	3200
		HLMP-EL30-STK00	—	1900	3200
		HLMP-EL30-SV000	—	1900	5500
	Orange 605	HLMP-EJ30-NR000	—	680	1900
		HLMP-EJ30-PS000	HLMP-EJ32-PS000	880	2500
	Red-Orange 615	HLMP-EH30-MQ000	—	520	1500
		HLMP-EH30-PS000	—	880	2500
	Red 626	HLMP-EG30-KN000	—	310	880
		HLMP-EG30-MQ000	—	520	1500
		HLMP-EG30-NQ000	—	680	1500
		HLMP-EG30-NR000	HLMP-EG32-NR000	680	1900
		HLMP-EG30-PQ000	—	880	1500
		HLMP-EG30-PR000	—	880	1900
		HLMP-EG30-PS000	—	880	2500
		HLMP-EG30-QT000	—	1150	3200

- a. θ_{1/2} is the off-axis angle where the luminous intensity is half the on-axis intensity.
- b. The dominant wavelength, λ_d, is derived from the CIE Chromaticity Diagram and represents the color of the lamp.
- c. The luminous intensity is measured on the mechanical axis of the lamp package.
- d. The optical axis is closely aligned with the package mechanical axis.
- e. Tolerance for each intensity bin limit is ±15%.

Part Numbering System

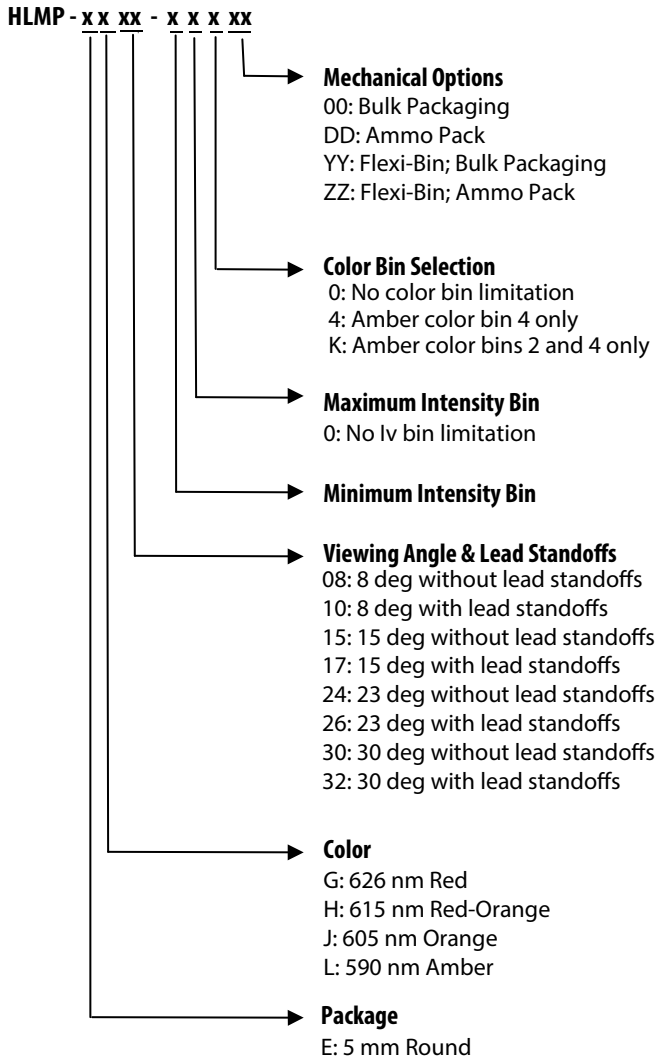

Note: Refer to AB 5337 for complete information on part numbering system.

Package Dimensions

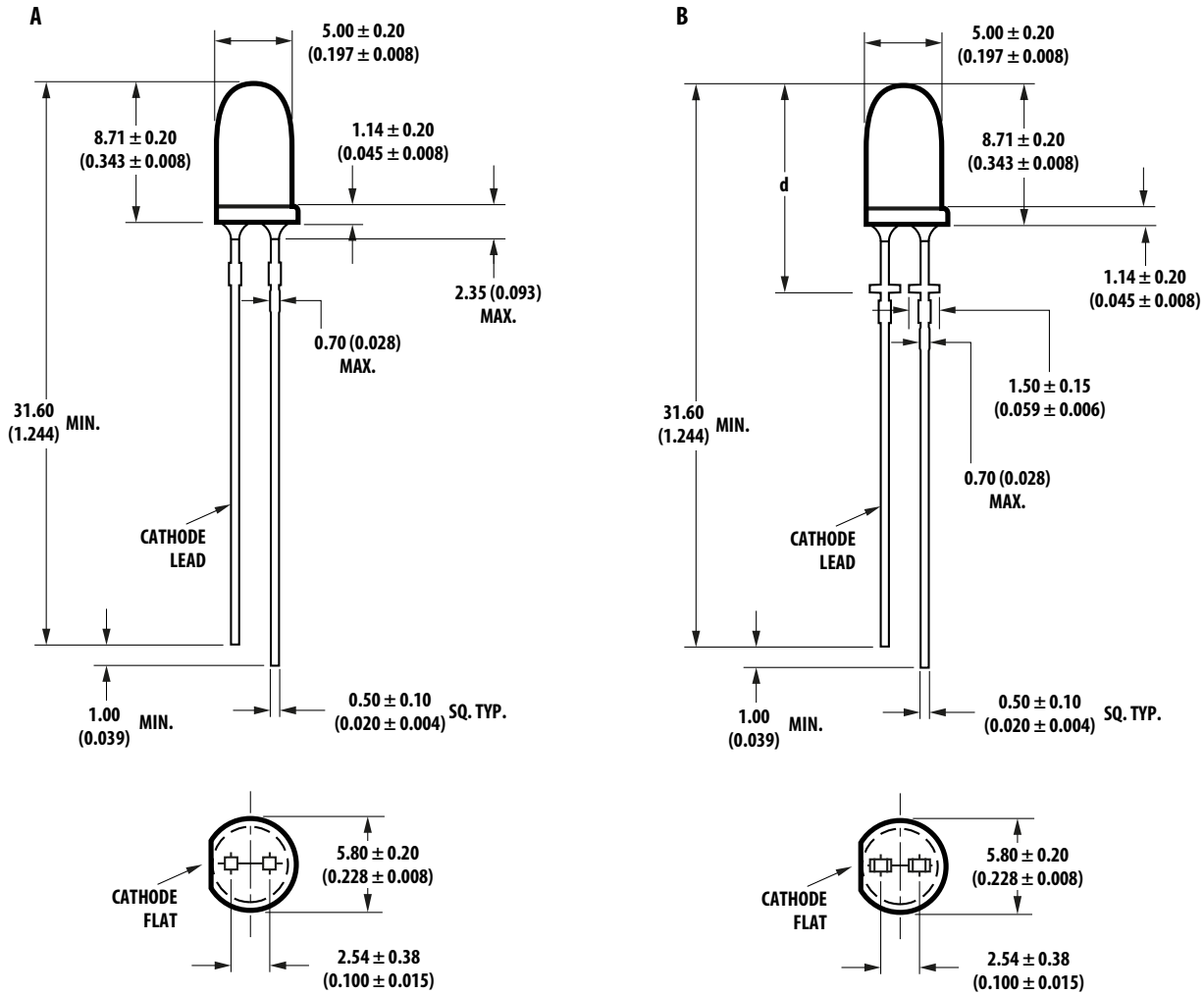

PART NO.	HLMP-XX10	HLMP-XX17	HLMP-XX26	HLMP-XX32
d	12.37 ± 0.25 (0.487 ± 0.010)	12.42 ± 0.25 (0.489 ± 0.010)	12.52 ± 0.25 (0.493 ± 0.010)	11.96 ± 0.25 (0.471 ± 0.010)

NOTE

1. All dimensions are in millimeters (inches).
2. Tapers shown at top of leads (bottom of lamp package) indicate an epoxy meniscus that may extend about 1 mm (0.040 in.) down the leads.
3. For dome heights above lead standoff seating plane, d, lamp package B, see table.

Absolute Maximum Ratings at $T_A = 25\text{ }^\circ\text{C}$

DC Forward Current ^{a,b,c}	50 mA
Peak Pulsed Forward Current ^{b,c}	100 mA
Average Forward Current ^c	30 mA
Reverse Voltage ($I_R = 100\text{ }\mu\text{A}$)	5 V
LED Junction Temperature	130 $^\circ\text{C}$
Operating Temperature	-40 $^\circ\text{C}$ to +100 $^\circ\text{C}$
Storage Temperature	-40 $^\circ\text{C}$ to +100 $^\circ\text{C}$

- a. Derate linearly as shown in [Figure 4](#).
- b. For long-term performance with minimal light output degradation, drive currents between 10 mA and 30 mA are recommended. For more information on recommended drive conditions, refer to Application Brief I-024.
- c. Operating at currents below 1 mA is not recommended. Contact your local representative for further information.

Electrical/Optical Characteristics at $T_A = 25\text{ }^\circ\text{C}$

Parameter	Symbol	Min	Typ	Max	Unit	Test Conditions
Forward Voltage Amber ($\lambda_d = 590\text{ nm}$) Orange ($\lambda_d = 605\text{ nm}$) Red-Orange ($\lambda_d = 615\text{ nm}$) Red ($\lambda_d = 626\text{ nm}$)	V_F		2.02 1.98 1.94 1.90	2.4 2.4 2.4 2.4	V	$I_F = 20\text{ mA}$
Reverse Voltage	V_R	5	20		V	$I_R = 100\text{ }\mu\text{A}$
Dominant Wavelength Red Amber Orange Red Orange	λ_d	620.0 584.5 599.5 612.0	626.0 590.0 605.0 615.0	630.0 594.5 610.5 621.7	nm	$I_F = 20\text{ mA}$
Peak Wavelength Amber ($\lambda_d = 590\text{ nm}$) Orange ($\lambda_d = 605\text{ nm}$) Red-Orange ($\lambda_d = 615\text{ nm}$) Red ($\lambda_d = 626\text{ nm}$)	λ_{PEAK}		592 609 621 635		nm	Peak of Wavelength of Spectral Distribution at $I_F = 20\text{ mA}$
Spectral Halfwidth	$\Delta\lambda_{1/2}$		17		nm	Wavelength Width at Spectral Distribution $1/2$ Power Point at $I_F = 20\text{ mA}$
Speed of Response	τ_s		20		ns	Exponential Time Constant, e^{-t/τ_s}
Capacitance	C		40		pF	$V_F = 0, f = 1\text{ MHz}$
Thermal Resistance	$R\theta_{J-PIN}$		240		$^\circ\text{C/W}$	LED Junction-to-Cathode Lead
Luminous Efficacy ^a Amber ($\lambda_d = 590\text{ nm}$) Orange ($\lambda_d = 605\text{ nm}$) Red-Orange ($\lambda_d = 615\text{ nm}$) Red ($\lambda_d = 626\text{ nm}$)	η_V		480 370 260 150		lm/W	Emitted Luminous Flux/Electrical Power
Luminous Flux	Φ_V		500		mlm	$I_F = 20\text{ mA}$
Luminous Efficiency ^b Red Amber Orange Red Orange	η_e		12 13 13 13		lm/W	Emitted Luminous Flux/Electrical Power

- a. The radiant intensity, I_e , in watts per steradian, may be found from the equation $I_e = I_v / \eta_V$, where I_v is the luminous intensity in candelas and η_V is the luminous efficacy in lumens/watt.
- b. $\eta_e = \Phi_V / I_F \times V_F$, where Φ_V is the emitted luminous flux, I_F is electrical forward current, and V_F is the forward voltage.

Figure 1 Relative Intensity vs. Peak Wavelength

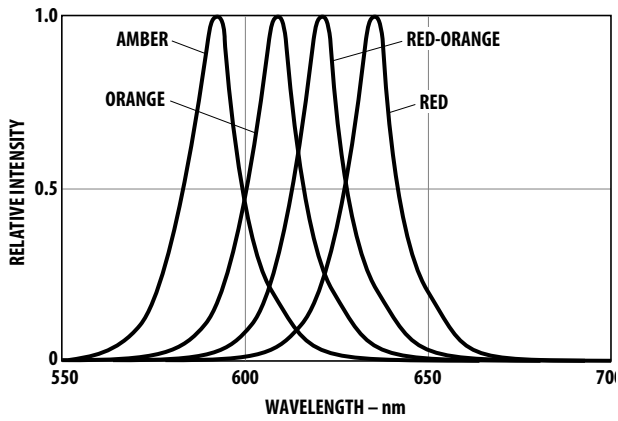

Figure 2 Forward Current vs. Forward Voltage

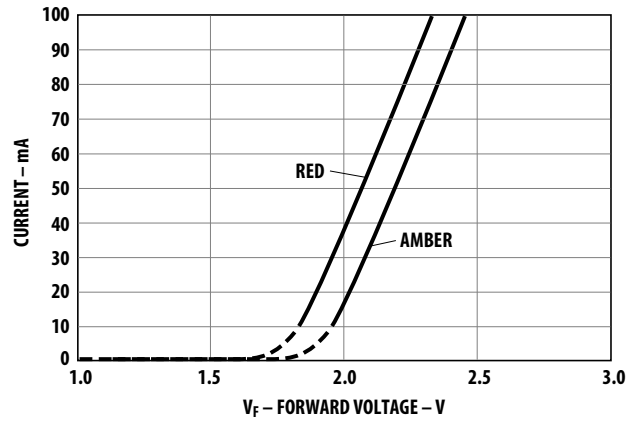

Figure 3 Relative Luminous Intensity vs. Forward Current

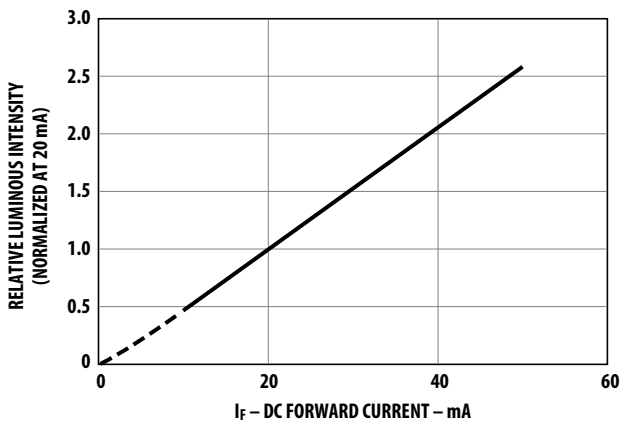

Figure 4 Maximum Forward Current vs. Ambient Temperature

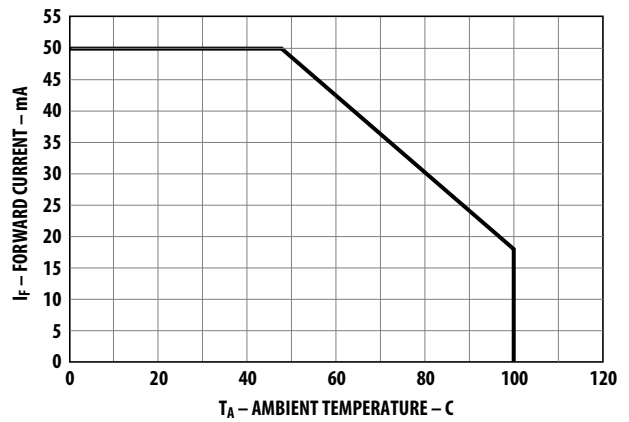

Figure 5 Representative Spatial Radiation Pattern for 8° Viewing Angle Lamps

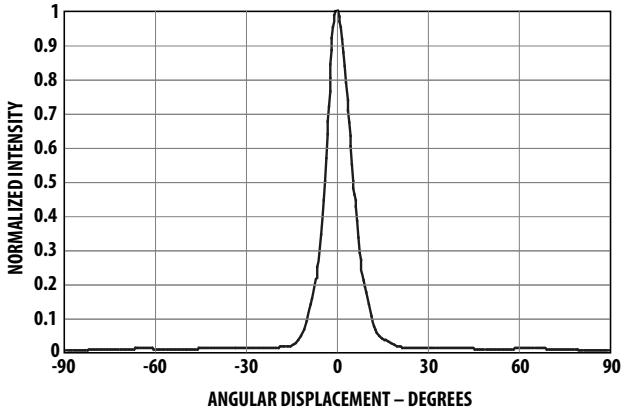

Figure 6 Representative Spatial Radiation Pattern for 15° Viewing Angle Lamps

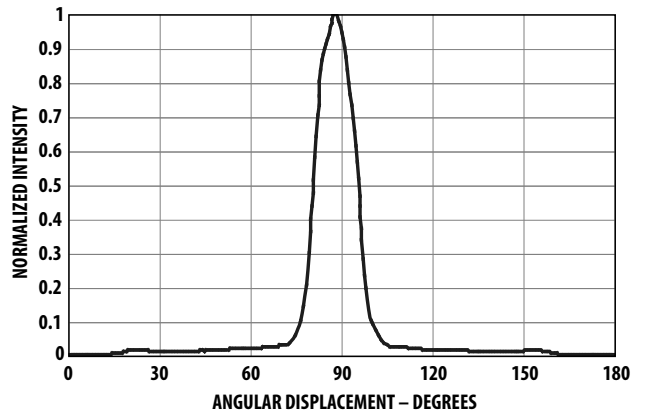

Figure 7 Representative Spatial Radiation Pattern for 23° Viewing Angle Lamps

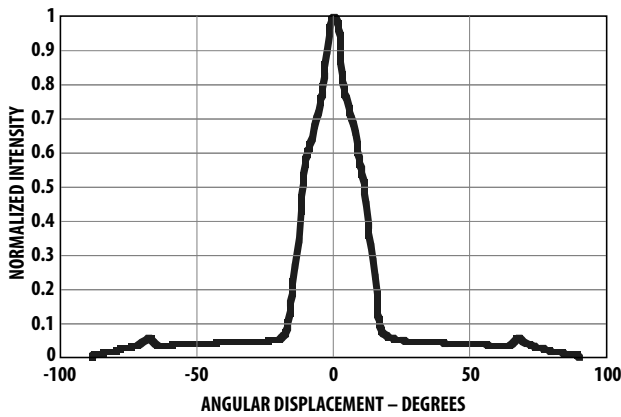

Figure 8 Representative Spatial Radiation Pattern for 30° Viewing Angle Lamps

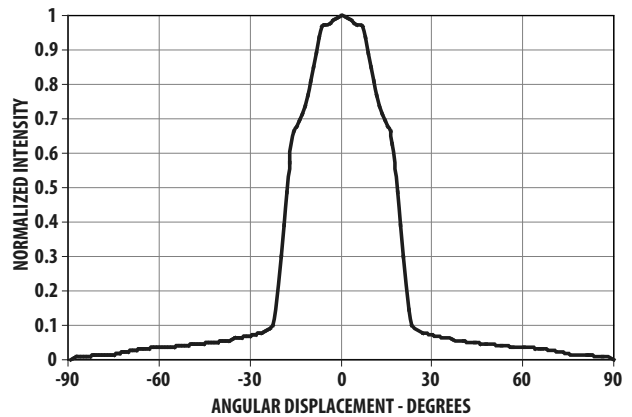
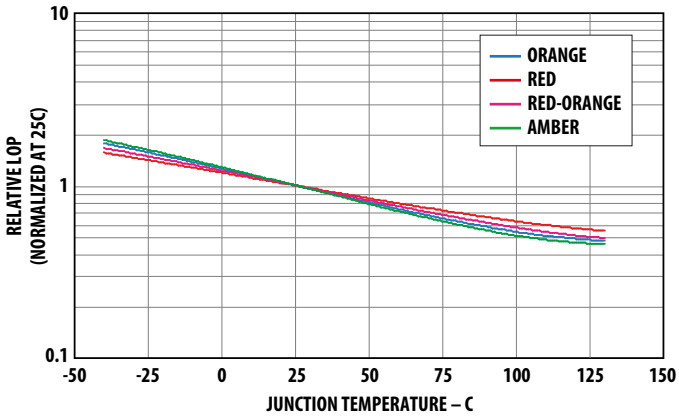

Figure 9 Relative Light Output vs. Junction Temperature



Amber Color Bin Limits (nm at 20 mA)

Bin Name ^{a,b}	Min	Max
1	584.5	587
2	587	589.5
4	589.5	592
6	592	594.5

- a. Tolerance for each bin limit is ±0.5 nm.
- b. Bin categories are established for classification of products. Products may not be available in all bin categories.

Intensity Bin Limits (mcd at 20 mA)

Bin Name ^a	Min	Max
K	310	400
L	400	520
M	520	680
N	680	880
P	880	1150
Q	1150	1500
R	1500	1900
S	1900	2500
T	2500	3200
U	3200	4200
V	4200	5500
W	5500	7200
X	7200	9300
Y	9300	12000
Z	12000	16000
1	16000	21000
2	21000	27000

- a. Tolerance for each bin limit is ±15%.

Precautions

Lead Forming

- The leads of an LED lamp may be preformed or cut to length prior to insertion and soldering on PC board.
- For better control, it is recommended to use the proper tool to precisely form and cut the leads to the applicable length rather than doing it manually.
- If manual lead cutting is necessary, cut the leads after the soldering process. The solder connection forms a mechanical ground that prevents mechanical stress due to lead cutting from traveling into LED package. This is highly recommended for hand soldering operation, as the excess lead length also acts as small heat sink.

Soldering and Handling

- Take care during PCB assembly and soldering process to prevent damage to the LED component.
- LED component may be effectively hand soldered to PCB. However, it is recommended only under unavoidable circumstances, such as rework. The closest manual soldering distance of the soldering heat source (soldering iron's tip) to the body is 1.59 mm. Soldering the LED using soldering iron tip closer than 1.59 mm might damage the LED.

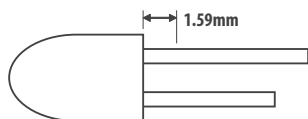

- ESD precautions must be properly applied on the soldering station and personnel to prevent ESD damage to the LED component that is ESD sensitive. Refer to Avago application note AN 1142 for details. The soldering iron used should have a grounded tip to ensure electrostatic charge is properly grounded.

- Recommended soldering condition:

	Wave Soldering ^{a,b}	Manual Solder Dipping
Pre-heat temperature	105 °C Max.	—
Preheat time	60 sec Max	—
Peak temperature	250 °C Max.	260 °C Max.
Dwell time	3 sec Max.	5 sec Max

- Above conditions refer to measurement with thermocouple mounted at the bottom of PCB.
 - It is recommended to use only bottom preheaters in order to reduce thermal stress experienced by LED.
- Wave soldering parameters must be set and maintained according to the recommended temperature and dwell time. The customer is advised to perform daily checks on the soldering profile to ensure that it is always conforming to recommended soldering conditions.

NOTE

1. PCBs with different size and design (component density) will have different heat mass (heat capacity). This might cause a change in temperature experienced by the board if the same wave soldering setting is used. So, it is recommended to recalibrate the soldering profile again before loading a new type of PCB.
2. Avago Technologies' AlInGaP high brightness LEDs are using a high efficiency LED die with a single wire bond as shown below. The customer is advised to take extra precautions during wave soldering to ensure that the maximum wave temperature does not exceed 250 °C and the solder contact time does not exceed 3 s. Overstressing the LED during the soldering process might cause premature failure to the LED due to delamination.

Avago Technologies LED Configuration

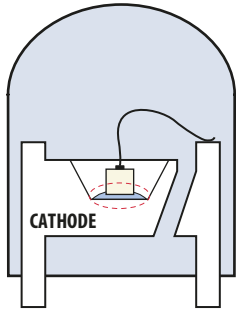

Note: Electrical connection between bottom surface of LED die and the lead frame is achieved through conductive paste.

- Any alignment fixture that is being applied during wave soldering should be loosely fitted and should not apply weight or force on LED. Nonmetal material is recommended as it will absorb less heat during wave soldering process.
- At elevated temperature, LED is more susceptible to mechanical stress. Therefore, the PCB must be allowed to cool down to room temperature prior to handling, which includes removal of alignment fixture or pallet.
- If the PCB board contains both through hole (TH) LED and other surface mount components, it is recommended that surface mount components be soldered on the top side of the PCB. If the surface mount must be on the bottom side, these components should be soldered using reflow soldering prior to insertion of the TH LED.

- The following table shows the recommended PC board plated through holes (PTH) size for LED component leads.

LED Component Lead Size	Diagonal	Plated Through Hole Diameter
0.45 × 0.45 mm (0.018 × 0.018 inch)	0.636 mm (0.025 in.)	0.98 to 1.08 mm (0.039 to 0.043 in.)
0.50 × 0.50 mm (0.020 × 0.020 inch)	0.707 mm (0.028 in.)	1.05 to 1.15 mm (0.041 to 0.045 in.)

- Over-sizing the PTH can lead to a twisted LED after clinching. On the other hand, under-sizing the PTH can cause difficulty when inserting the TH LED.

NOTE Refer to application note AN5334 for more information about soldering and handling of high brightness TH LED lamps.

Application Precautions

1. The drive current of the LED must not exceed the maximum allowable limit across temperature as stated in the data sheet. Constant current driving is recommended to ensure consistent performance.
2. LEDs do exhibit slightly different characteristics at different drive currents that might result in larger performance variations (such as intensity, wavelength, and forward voltage). The user is recommended to set the application current as close as possible to the test current to minimize these variations.
3. The LED is not intended for reverse bias. Use other appropriate components for such purposes. When driving the LED in matrix form, it is crucial to ensure that the reverse bias voltage does not exceed the allowable limit of the LED.

Example of Wave Soldering Temperature Profile for TH LED

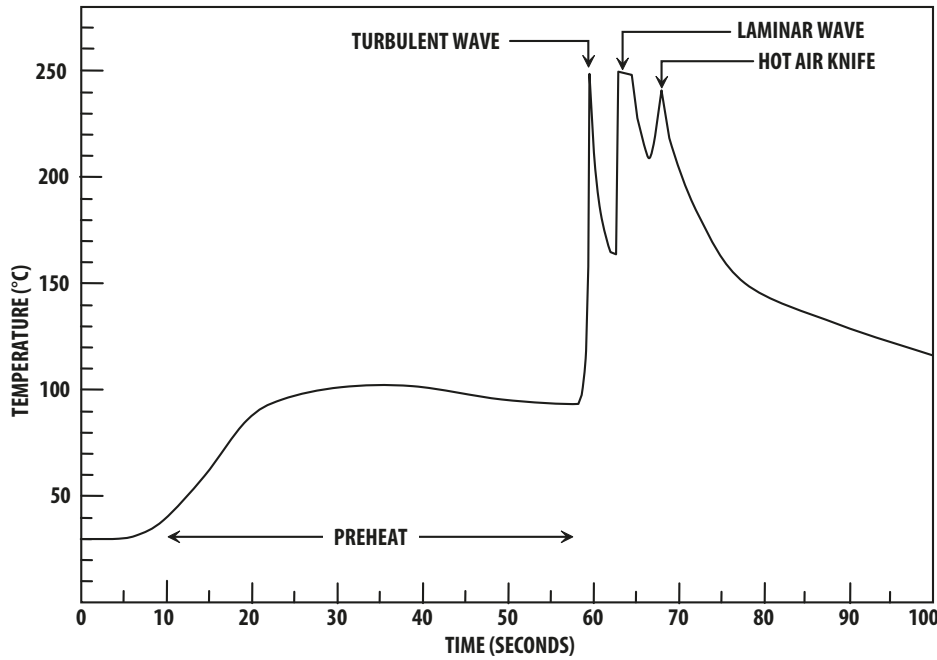

Recommended solder:
Sn63 (Leaded solder alloy)
SAC305 (Lead free solder alloy)

Flux: Rosin flux

Solder bath temperature:
245°C ± 5°C (maximum peak
temperature = 250°C)

Dwell time: 1.5 sec - 3.0 sec
(maximum = 3sec)

Note: Allow for board to be sufficiently
cooled to room temperature before
exerting mechanical force.

Ammo Pack Drawing

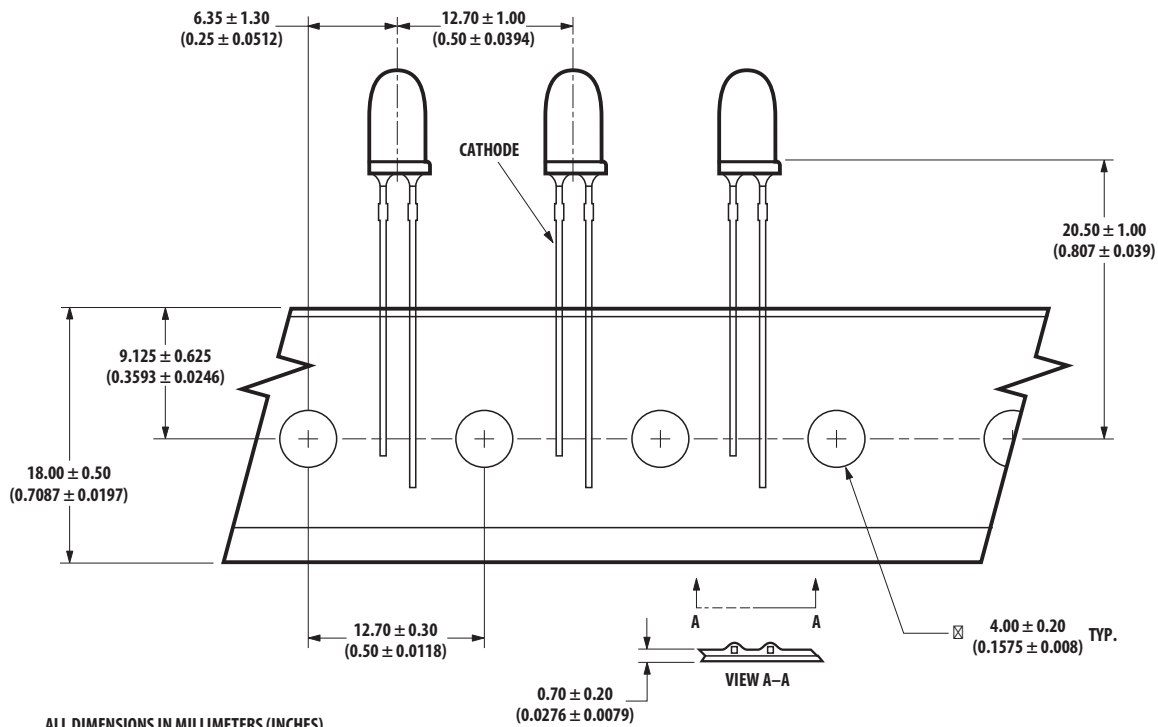

ALL DIMENSIONS IN MILLIMETERS (INCHES).

NOTE: THE AMMO-PACKS DRAWING IS APPLICABLE FOR PACKAGING OPTION -DD & -ZZ AND REGARDLESS OF STANDOFF OR NON-STANDOFF.

Packaging Box for Ammo Packs

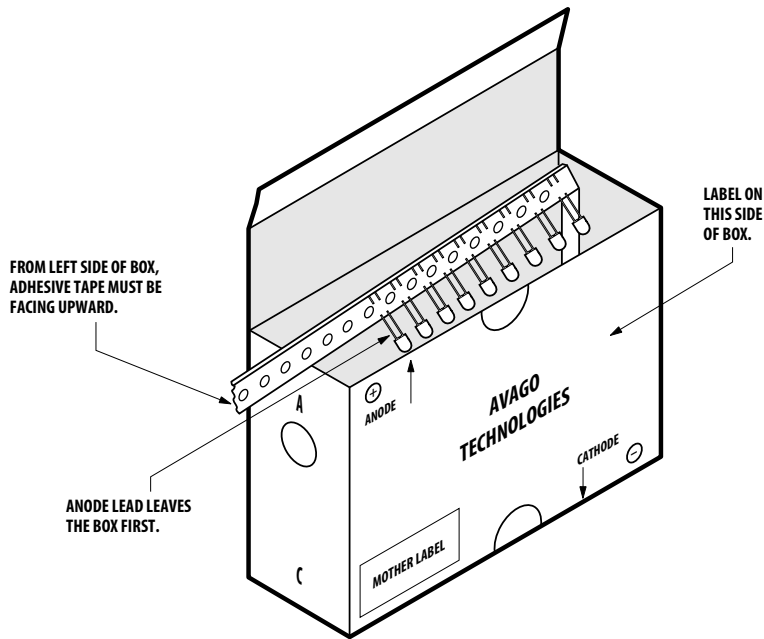











NOTE:
THE DIMENSION FOR AMMO PACK IS APPLICABLE FOR THE DEVICE WITH STANDOFF AND WITHOUT STANDOFF.

Packaging Label

(i) Avago Mother Label: (Available on packaging box of ammo pack and shipping box)

Avago TECHNOLOGIES	
(1P) Item: Part Number [Barcode]	STANDARD LABEL LS0002 RoHS Compliant e3 max temp 250C
(1T) Lot: Lot Number [Barcode]	(Q) QTY: Quantity [Barcode]
LPN: [Barcode]	CAT: Intensity Bin [Barcode]
(9D)MFG Date: Manufacturing Date [Barcode]	BIN: Refer to below information
<hr/>	
(P) Customer Item: [Barcode]	
(V) Vendor ID: [Barcode]	(9D) Date Code: Date Code [Barcode]
DeptID: [Barcode]	Made In: Country of Origin [Barcode]

(ii) Avago Baby Label (Only available on bulk packaging)

	
Lamps Baby Label	
(1P) PART #: Part Number 	RoHS Compliant e3 max temp 250C
(1T) LOT #: Lot Number 	
(9D)MFG DATE: Manufacturing Date 	QUANTITY: Packing Quantity 
C/O: Country of Origin	
Customer P/N: 	CAT: Intensity Bin 
Supplier Code: 	BIN: Refer to below information 
	DATECODE: Date Code 

Acronyms and Definitions

BIN:

- (i) Color bin only or VF bin only
 - Applicable for part number with color bins but without VF bin OR part number with VF bins and no color bin

OR

- (ii) Color bin incorporated with VF Bin
 - Applicable for part number that have both color bin and VF bin

Example:

- (i) Color bin only or VF bin only
 - BIN: 2 (represent color bin 2 only)
 - BIN: VB (represent VF bin "VB" only)
- (ii) Color bin incorporate with VF Bin
 - BIN: 2VB, where:
 - 2 is color bin 2 only
 - VB is VF bin "VB"

DISCLAIMER: AVAGO'S PRODUCTS AND SOFTWARE ARE NOT SPECIFICALLY DESIGNED, MANUFACTURED OR AUTHORIZED FOR SALE AS PARTS, COMPONENTS OR ASSEMBLIES FOR THE PLANNING, CONSTRUCTION, MAINTENANCE OR DIRECT OPERATION OF A NUCLEAR FACILITY OR FOR USE IN MEDICAL DEVICES OR APPLICATIONS. CUSTOMER IS SOLELY RESPONSIBLE, AND WAIVES ALL RIGHTS TO MAKE CLAIMS AGAINST AVAGO OR ITS SUPPLIERS, FOR ALL LOSS, DAMAGE, EXPENSE OR LIABILITY IN CONNECTION WITH SUCH USE.

For product information and a complete list of distributors, please go to our web site:

www.avagotech.com

Avago Technologies and the A logo are trademarks of Avago Technologies in the United States and other countries. All other brand and product names may be trademarks of their respective companies.

Data subject to change. Copyright © 2016 Avago Technologies. All Rights Reserved.

AV02-0373EN – June 1, 2016

AVAGO
TECHNOLOGIES



Lead (Pb) Free
RoHS 6 fully
compliant

Mouser Electronics

Authorized Distributor

Click to View Pricing, Inventory, Delivery & Lifecycle Information:

Avago Technologies:

[HLMP-EG08-T0000](#) [HLMP-EG08-VY000](#) [HLMP-EG08-WZ000](#) [HLMP-EG08-WZ0DD](#) [HLMP-EG08-X1000](#) [HLMP-EG08-X10DD](#) [HLMP-EG08-Y2000](#) [HLMP-EG08-Y20DD](#) [HLMP-EG08-YZ000](#) [HLMP-EG08-YZ0DD](#) [HLMP-EG08-Z2000](#) [HLMP-EG10-T0000](#) [HLMP-EG10-WZ000](#) [HLMP-EG10-X1000](#) [HLMP-EG10-X10DD](#) [HLMP-EG10-Y2000](#) [HLMP-EG10-Y20DD](#) [HLMP-EG15-N0000](#) [HLMP-EG15-PS000](#) [HLMP-EG15-QT000](#) [HLMP-EG15-QT0DD](#) [HLMP-EG15-RU000](#) [HLMP-EG15-SV000](#) [HLMP-EG15-TW000](#) [HLMP-EG15-TW0DD](#) [HLMP-EG15-UX000](#) [HLMP-EG15-UX0DD](#) [HLMP-EG17-N0000](#) [HLMP-EG17-QT000](#) [HLMP-EG17-RU0DD](#) [HLMP-EG17-SV000](#) [HLMP-EG17-TW000](#) [HLMP-EG17-UX000](#) [HLMP-EG24-M0000](#) [HLMP-EG24-PQ0DD](#) [HLMP-EG24-PS000](#) [HLMP-EG24-PS002](#) [HLMP-EG24-PS0DD](#) [HLMP-EG24-PS0YY](#) [HLMP-EG24-QT000](#) [HLMP-EG24-RU000](#) [HLMP-EG24-SV0DD](#) [HLMP-EG26-M0000](#) [HLMP-EG26-PS000](#) [HLMP-EG26-PS0DD](#) [HLMP-EG26-RU000](#) [HLMP-EG26-RU0DD](#) [HLMP-EG30-K0000](#) [HLMP-EG30-KN000](#) [HLMP-EG30-KN0DD](#) [HLMP-EG30-LP0DD](#) [HLMP-EG30-MQ000](#) [HLMP-EG30-MQ0DD](#) [HLMP-EG30-NQ000](#) [HLMP-EG30-NQ0DD](#) [HLMP-EG30-NR000](#) [HLMP-EG30-NR0DD](#) [HLMP-EG30-PQ000](#) [HLMP-EG30-PQ0DU](#) [HLMP-EG30-PR000](#) [HLMP-EG30-PS000](#) [HLMP-EG30-PS0DD](#) [HLMP-EG30-QT000](#) [HLMP-EG30-QT0DD](#) [HLMP-EG30-RS0DD](#) [HLMP-EG32-K0000](#) [HLMP-EG32-MQ000](#) [HLMP-EG32-MQ0DD](#) [HLMP-EG32-NR000](#) [HLMP-EG32-NR0DD](#) [HLMP-EG32-PS000](#) [HLMP-EG32-QT000](#) [HLMP-EG32-QT0DD](#) [HLMP-EG32-RU0DD](#) [HLMP-EH08-UX000](#) [HLMP-EH08-WZ000](#) [HLMP-EH08-X1000](#) [HLMP-EH08-Y2000](#) [HLMP-EH08-Y20DD](#) [HLMP-EH10-UX000](#) [HLMP-EH10-WZ000](#) [HLMP-EH10-X10DD](#) [HLMP-EH10-Y2000](#) [HLMP-EH10-Y20DD](#) [HLMP-EH15-QT002](#) [HLMP-EH15-RU000](#) [HLMP-EH15-RU0DD](#) [HLMP-EH15-TW000](#) [HLMP-EH15-UX000](#) [HLMP-EH17-SV0DD](#) [HLMP-EH17-TW000](#) [HLMP-EH17-UX000](#) [HLMP-EH24-PS000](#) [HLMP-EH24-QT000](#) [HLMP-EH24-RU000](#) [HLMP-EH24-RU0DD](#) [HLMP-EH24-SV000](#) [HLMP-EH26-PS000](#) [HLMP-EH26-SV000](#) [HLMP-EH30-MQ000](#)